

REV.	Description	Date
1	dimensions revised	2020/2/5

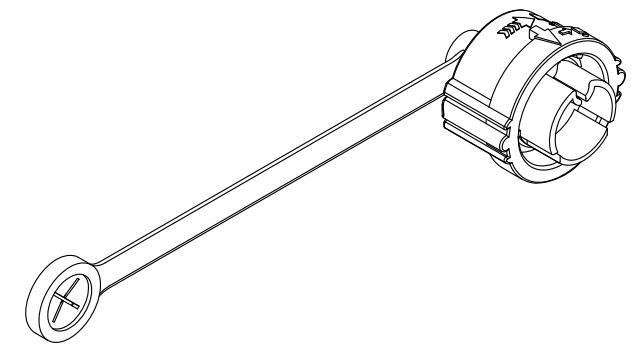

RoHS
TOLERANCE ±0.5

5	Screw	SUS	
4	Washer	SUS	
3	Cable tie	PVC	
2	O ring	Rubber	
1	Cap	PA	
Item	Description	Material	Treat & Remark

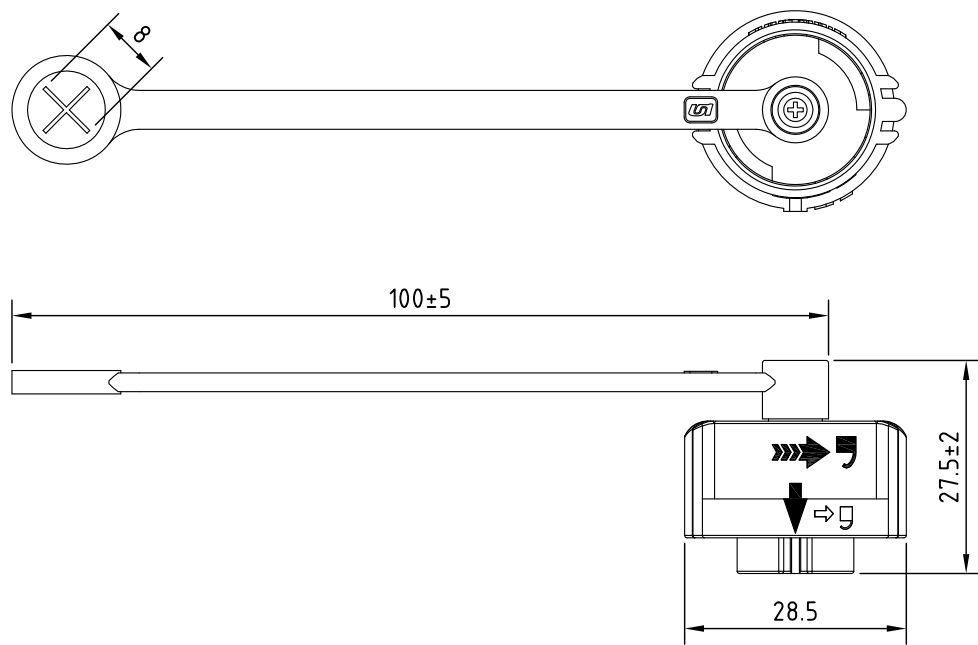

Unicable Co., Ltd. 國陽電業有限公司

5F., No. 111-33, Sec. 4, San Ho Road., San Chung Dist., New Taipei City, Taiwan, R.O.C.
http://www.unicable.com.tw TEL:+886-2-2286-2122 FAX:+886-2-2286-1010

DATE	2020/2/5	PART NO.	UT-D365C-6C
DWN	GINA	REV.	1
CHK			
UNIT	MM		

ITEM	Type J(J4): waterproof cap
------	----------------------------